



INSTALLATION GUIDE FOR PHOTOVOLTAIC (PV) MODULES

Contents

1. Purpose of this Guide.....	3
1.1. Disclaimer of Liability	3
1.2 General Safety.....	3
1.3 Safety Precaution Measures	3
2. Product Identification	4
3. Installation Considerations	4
3.1 Unpacking and Storing	4
3.2 Pre-Installation Requirements	4
3.3 Site Considerations	5
3.4 System Fire Rating.....	5
4. Module Mounting	5
4.1 Bolting	5
4.2 Top Down Clamps	6
4.3 Grounding	6
5. Electrical Installation	6
5.1 Cables and Wiring	6
5.2 Bypass Diodes	7
5.3 General Installation.....	8
5.4 Grid Connected Electrical System	8
6. Commission and Maintenance	8
6.1 Testing, Commissioning, and Troubleshooting.....	8
6.2 Maintenance	9
6.3 Replacing Bypass Diodes.....	9

1. Purpose of this Guide

This guide contains information regarding the installation for solar modules. All instructions should be read and understood before attempting to install. If there are any questions, please contact us for further explanation. The installer should conform to all the safety precautions listed in this guide when installing the module. Local codes should also be followed in such installations. Before installing a solar photovoltaic system, the installer should become familiar with the mechanical and electrical requirement for such a system. Keep this guide in a safe place for future reference (care and maintenance) and in case of sale or disposal of the module at the end of its useful life.

This document is applicable to the series of solar modules listed below:

- ❖ RNG-300D; RNG-160D-SS; RNG-100D; RNG-100D-SS; RNG-100MB; RNG-100D-R; RNG-100D-R-BK; RNG-80D-SS; RNG-50D; RNG-30D; RNG-30D-SS; RNG-20D; RNG-10D; RNG-10D-SS
- ❖ RNG-270P; RNG-160P; RNG-100P; RNG-50P

1.1. Disclaimer of Liability

- ❖ Because the use of this manual and the conditions or methods of installation, operation, use and maintenance of photovoltaic (PV) product are beyond Renogy's control, Renogy does not accept responsibility and expressly disclaims liability for loss, damage, or expense arising out of or in any way connected with such installation, operation, use or maintenance.
- ❖ No responsibility is assumed by Renogy for any infringement of patents or other rights of third parties, which may result from use of the PV product. No license is granted by implication or otherwise under any patent or patent rights. The information in this manual is based on Renogy's knowledge and experience and is believed to be reliable; but such information including product specification (without limitations) and suggestions do not constitute a warranty, expresses or implied. Renogy reserve the right to change the manual, the PV produce, the specifications, or product information sheets without prior notice.

1.2 General Safety

Installing solar photovoltaic systems may require specialized skills and knowledge. Installation should be performed only by qualified personnel. All modules come with a permanently attached junction box and #12 AWG wire terminated in connectors. Renogy can provide customers with fitted cables for ease of installation, if desired. The installer should assume the risk of all injury that might occur during installation, including, without limitation, the risk of electric shock.

One individual module may generate DC voltages greater than 30 volts when exposed to direct sunlight. Contact with a DC voltage of 30V or more

is potentially hazardous. When disconnecting wires connected to a photovoltaic module that is exposed to sunlight, an electric arc may result. Such arcs may cause burns, may start fires and may otherwise create problems. Therefore, be extremely careful!

Solar modules change light energy to direct-current electrical energy. They are designed for outdoor use. Modules may be ground mounted, mounted on roof, vehicles or boats. Proper design of support structures is the responsibility of the system designer and installer.

- ❖ Do not attempt to disassemble the module, and do not remove any attached nameplates or components.
- ❖ Do not apply paint or adhesive to module top surface.
- ❖ Do not use artificially concentrated sunlight directly on the module.

When installing the system, abide with all local, regional and national statutory regulations. Obtain a building permit where necessary. Abide with any local and national regulations when mounting on vehicles or boats. Safety precaution for installing a solar photovoltaic system

1.3 Safety Precaution Measures



Solar modules produce electrical energy when light shines on their front surface. The DC voltage may exceed 30V. If modules are connected in series, the total voltage is equal to the sum of the individual module voltages. If modules are connected in parallel, the total current is equal to the sum of individual module currents.

- ❖ Keep children well away from the system while transporting and installing mechanical and electrical components.
- ❖ Completely cover the module with an opaque material during installation to keep electricity from being generated.
- ❖ Do not wear metallic rings, watchbands, ear, nose, lip rings or other metallic devices while installing or troubleshooting photovoltaic systems.
- ❖ Use only insulated tools that are approved for working on electrical installations.
- ❖ Abide with the safety regulations for all other components used in the system, including wiring and cables, connectors, charging regulators, inverters, storage batteries and rechargeable batteries, etc.
- ❖ Use only equipment, connectors, wiring and support frames suitable for use in solar electric systems. Always use the same type of module within a particular photovoltaic system.

Under normal outdoor conditions the module will produce current and voltages that are different than those listed in the data sheet. Data sheet values are values expected at standard test conditions.

2. Product Identification

- ❖ Renogy modules have been qualified for Application Class A. Modules qualified for safety through IEC 61140 and within this application class are considered to meet the requirements for Safety Class II. Modules rated under this class should be used in systems operating at a voltage above 50 VDC or power above 240 W, where general contact access is anticipated.

A photovoltaic system composed of UL1703 certified modules mounted on a UL2703 certified mounting system should be evaluated in combination with roof coverings in accordance with UL1703 standard, with respect to meeting the same fire classification as the roof assembly. UL-1703, includes revisions through October 12, 2015, Section 16 and 31.1.2; UL790-2014

- ❖ Module Fire Performance Type 1
 - Mounting systems with a System Fire Class Rating (Class A, B, or C), tested in conjunction with fire rated "Type 1" modules, are considered to be acceptable for use by Renogy.

Each module has three labels on its rear side providing the following information:

- ❖ Nameplate: describes the product type; rated power, rated current, rated voltage, open circuit voltage, short circuit current, all as measured under standard test conditions; weight, dimension etc.

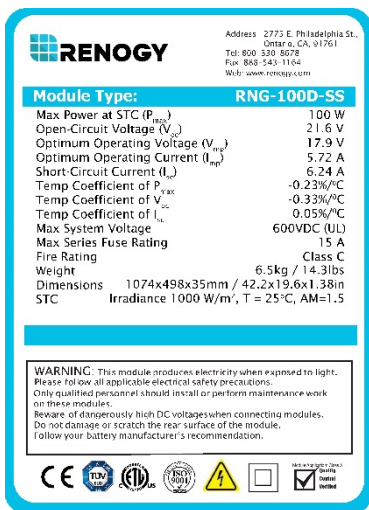

- ❖ Bar code: each individual module has a unique serial number.
- ❖ Do not remove any label. If the label is removed the product warranty will no longer be honored by Renogy.

3. Installation Considerations



Before installing, obtain information about any requirements and pre-approvals for the site, installation, and inspection from the relevant authorities.

- ❖ Check applicable building codes and ensure that the structure can bear the module system load
- ❖ Ensure the supporting roof has fire resistant roof covering
- ❖ Renogy modules are listed as Class C under the UL790 Standard.

3.1 Unpacking and Storing



Unpack module pallets carefully, making sure to follow all directions on the pallet.

- ❖ Do not step, walk, stand, or jump on any modules. Localized heavy loads may cause variances of micro-cracks on the cells which will ultimately compromise module reliability
- ❖ Do not carry modules on your head or carry modules through the wires or junction box
- ❖ Do not use sharp instruments on the modules, especially the sensitive backsheet
- ❖ Do not leave modules unsupported or unsecured
- ❖ Keep all electrical contacts clean and dry

3.2 Pre-Installation Requirements

- ❖ Ensure that the modules meet the general technical system requirements.
- ❖ Ensure other system components do not damage the modules mechanically or electrically
- ❖ Modules can be wired in series to increase voltage or in parallel to increase current. Series connections have the modules go from positive of one module to negative of the second module. Parallel connections connect the positive cables of one module and the second module.
- ❖ Bypass diodes in the modules depends on the model itself.
- ❖ Modules must not be connected together to create a voltage that is higher than the maximum system voltage.
- ❖ A maximum of two strings can be connected in parallel without needing to incorporate an over-current protection device.
- ❖ Only modules with similar electrical output should be connected in the same string to avoid mismatch effects.
- ❖ The small drainage holes on the underside of the module must not be blocked.
- ❖ Avoid shading—even minor partial shading reduces yields. Sunlight should be able to reach the module even on the shortest day of the year. Shading can affect module service life.

- ❖ The module should be facing true south in northern latitudes and true north in southern latitudes for best power production.
- ❖ For detailed information on the best elevation tilt angle for the installation, refer to standard solar photovoltaic installation guides or a reputable solar installer or systems integrator.

3.3 Site Considerations

Renogy modules should be installed in locations that meet the following requirements:

- ❖ Operating Temperature within -40°F to 194°F
- ❖ Relative humidity within 45% to 95%
- ❖ Avoid trees, buildings, or obstructions

Renogy modules are designed with a mechanical load strength of 2400Pa

3.4 System Fire Rating

The fire rating of Renogy modules is only valid when mounted in the manner specified in the mechanical mounting instructions. When installing modules on rooftops, please ensure the assembly is mounted over a fire resistant roof covering rated for the application.

- ❖ Renogy non-BIPV modules are certified through Intertek as Type 1 for fire performance
- ❖ The System Fire Class Rating of the module or panel in a mounting system combination with a fire resistant roof rating is the only way to achieve this rating.
- ❖ Any system limitations on inclination or accessories required to maintain a specific Fire Class Rating should be clearly specified in the installation instructions and UL2703 Certification of the mounting system supplier
- ❖ The modules are intended for use in general open-air climate, as defined in IEC 60721-2-1: Classification of environment condition Part-2-1: environmental conditions appearing in nature temperature and humidity.
- ❖ To preserve individual module fire class rating, PV modules must be mounted on a non-combustible surface standoff height of at least 5 inches with 0° inclinations.

4. Module Mounting

- ❖ All installation methods herein are only for reference and Renogy will not provide their own mounting components. Instead, the system installer is responsible for making sure installation is abided by all codes.
- ❖ Any mounting system limitations on inclination or accessories required to maintain a specific System Fire Class Rating should be clearly specified in the installation instructions and UL2703 certification of the mounting system supplier.
- ❖ In order to maintain the fire class rating, the distance between the PV modules (front glass) and the roof surface should be at least 5 in.
- ❖ Module mounting must use the pre-drilled mounting holes (**Length * Width: 14mm x 9mm**) in the frame. The most common mounting is achieved by mounting the module using the four symmetry points close to the inner side on module frame. Refer to the following picture

for more details. Note that the holes in the center (blue) are for grounding.

- ❖ Modules should be safely fixed to bear all expected loads, including wind and snow loads. A minimum clearance of 0.25 in (6.5mm) or more between modules is required to allow for thermal expansion of the frames.

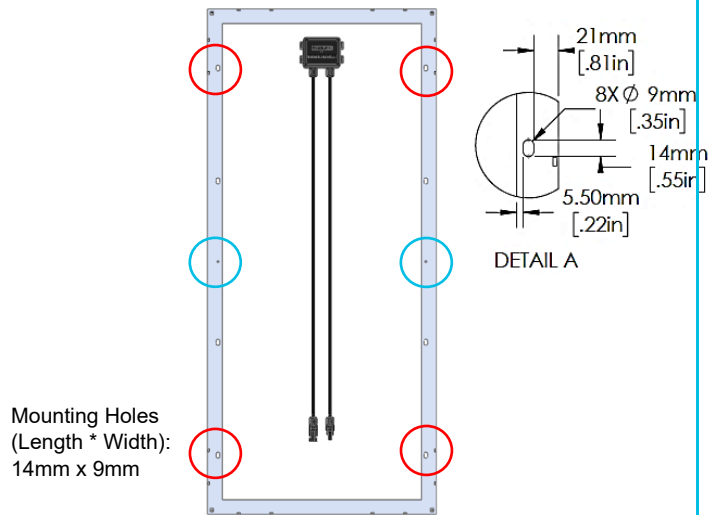

RNG100D Example

4.1 Bolting

Modules must be mounted using the mounting holes located on the rear side of the long frame parts using M6 or M8 bolt stainless steel bolts, nuts, and washers. Refer to the racking manufacturer for specific torque requirements.

The mounting design must be certified by a registered professional engineer and comply with local code requirements from relevant authorities.

- ❖ Use appropriate corrosion-proof fastening materials—should be stainless steel
- ❖ Do NOT drill holes or modify the module frame as it will void warranty.
- ❖ Each module must be securely fastened at a minimum of 4 points on two opposite sides. *Actual bolt depends on railing and professional installer.
- ❖ Design load and safety factors will be determined by racking suppliers or professional engineers.

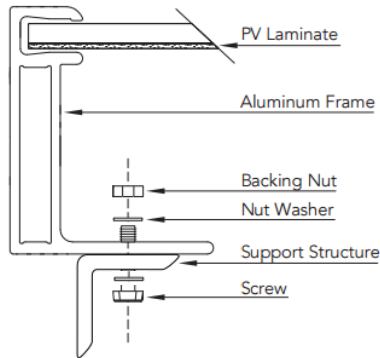
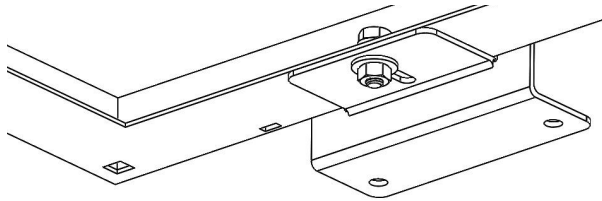

4.2 Top Down Clamps

Clamps are an approved method of mounting for Renogy modules. A clamp holds two modules in a row. The centerline of the clamps must be in-line with the module mounting holes and installed according to code.

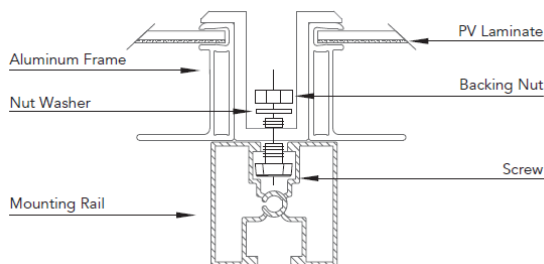

4.3 Grounding

The frame of the PV module, as well as any exposed non-current carrying metal parts of fixed equipment that can be energized must be grounded to avoid electrical shock. Renogy recommends grounding all PV module frames to ensure the voltage between the conductive equipment and the earth ground is zero in all circumstances.

Appropriate grounding consists of using an appropriately sized EGC or racking system that can be used for integrated grounding. Renogy panels implement a coated aluminum frame for corrosion resistance. The frame rails have pre-drilled holes marked with the grounding sign. Do not drill additional holes into the frame rails.

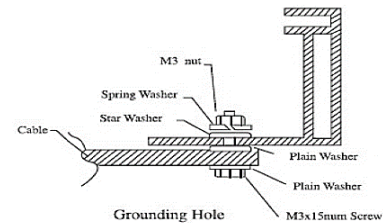
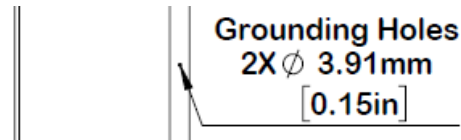

- ❖ Note that the stainless steel washer is used between the grounding wire and the module frame. This is for avoiding corrosion due to dissimilar metals.
- ❖ The module frame must be properly grounded (refer to NEC clause 250). The grounding wire must be properly fastened to the module frame to assure good electrical contact. Use the recommended type, or an equivalent, connector for this wire.
- ❖ If the support frame is made of metal, the surface of the frame must be electroplated and have excellent conductivity.
- ❖ We recommend the lay-in lug (Cat. No. GBL4-DBT; rated for 600Volts; company: ILSCO; UL number is E34440) when grounding. First strip 16mm insulating jacket from the end of the ground wire (4-14 STR.) carefully to avoid nicking or cutting conductors, insert the wire into the slot of the lug (see the picture), and screw down the slotted screw.
- ❖ Next, assemble the recommended ILSCO grounding lug to the aluminum frame using stainless steel M3 or M5 screw and hardware as shown below. Note: there are two different size grounding holes, the smaller of which is being phased out.
- ❖ Further, buildup of hardware for mounting the grounding lug are the same—except for the M3 screw, an added flat washer is mounted directly under the M3 screw head. The star washer is fitted directly under the grounding lug and makes electrical contact by penetrating the anodized coating of the aluminum frame. The screw assembly is further fitted with a flat washer, then a split lock washer and finally a nut to secure the entire assembly, as shown. Recommended torque of M3 or M5 screw assembly is 0.8NM or 1.5 NM.

5. Electrical Installation

5.1 Cables and Wiring

Renogy modules are equipped with two (2) stranded, PV-rated, output MC4 cables. The positive connector is a male connector and the negative connector is a female connector. These wires by themselves are rated for series connections, but could be adapted to hold parallel connections with

an extra component such as a combiner box or an MC4 adaptor for parallel strings. Renogy recommends that only sunlight resistant cables be used with the minimum wire size being 4mm² in diameter.

Wiring	Type	Ratings
PV Wire	PV1-F1x4.0mm ²	Rated Voltage: 1800VDC -40°C Up to 120°C
MC4 Connectors	LJQ-1	Rated Voltage:1800VDC Rated Current: 16A -40°C Up to 120°C
Junction Box	PV-JM801	Rated Voltage: 1000VDC Up to 15A

- ❖ MC4 cables are intended for use on the output wiring of a module or panel and comply with the Standard for Connectors for use in Photovoltaic Systems, UL 6703, see module literature for appropriate mating connectors.
- ❖ Keep connectors dry and clean and ensure that caps are tightly sealed before connecting modules
- ❖ Faulty connections can result in electrical shock so make sure to fasten all connections securely.
- ❖ Renogy modules can be installed in landscape or portrait orientation. Make sure that the proper distance between the panels and the surface to allow for air circulation.

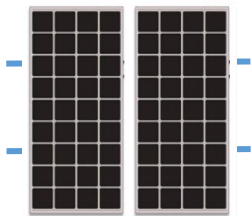

Portrait Orientation

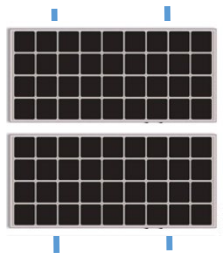

Landscape Orientation

- ❖ Series Connections are just plug and play with the male and female MC4 connectors

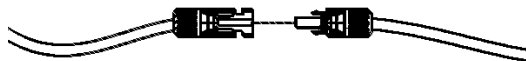

- ❖ Parallel connections will utilize MC4 branch connectors for centralizing all positive and all negative connections.



- ❖ Appropriate MC4 connectors will have a manufacturer name of the following:

Model
Renogy
Forward Electronics

Jiangsu Forward Electronic Technology Co., Ltd
No. 291 East Street, Zhulin Town, Jintan City, Jiangsu 213241 China

- ❖ Compatible manufacturers to Forward Electronics include Multi-Contact exclusively,
 - Female Type Multi-Contact KBT4/6I-UR (A: 4 - 6 mm², D: 5. 5 - 9 mm) (1302020)
 - Male Type Multi-Contact KST4/6II-UR (A: 4 - 6 mm², D: 5. 5 - 9 mm)
- ❖ Marking or unique physical features for the connectors will include the physical company name, a do not disconnect symbol, a TUV certification symbol on the actual connector, and a polarity band whether it be red or black,

5.2 Bypass Diodes

The junction boxes used with the Renogy modules contain bypass diodes that are wired in parallel with the PV string cells. In the event the modules experience partial shading, the diodes are activated to bypass the current generated by the non-shaded cells, therefore limiting module heating and performance losses. However, they do not protect the panel from over-current. Over-current protections devices must be used when connecting more than 2 modules in series.

If the bypass diodes are suspected of failure, installers or maintenance personnel should contact the company (Renogy).

Model	Rating
SPA2040	T _j Max = 200°C, if 20A

- ❖ In systems with more than two modules in series, high reverse current can flow through cells that are shaded partially or outright

when part of a module is shaded and the rest is exposed to the sun. These currents can cause the affected cells to get very hot and could even damage the module. To protect module from such high reverse currents

- ❖ All modules rated greater than 55 Watt have bypass diode already integrated in the junction box.
- ❖ In the unlikely event of diode failure Renogy recommends a qualified service technician be employed to determine if diodes have failed and to make replacement.

5.3 General Installation

- ❖ The modules are equipped with PV wiring connectors that comply with the Standard for Connectors for use in Photovoltaic Systems, UL 6703, see module literature for appropriate mating connectors.
- ❖ Do not use modules of different configurations in the same system. Several modules are connected in series and then in parallel to form a PV array, especially for application with a high operation voltage. If modules are connected in series, the total voltage is equal to the sum of individual voltages. For applications requiring high currents, several photovoltaic modules can be connected in parallel; the total current is equal to the sum of individual currents.
- ❖ Module is supplied with Multicontact connectors (PV-KBT4 and PV-KST4) to use for system electrical connections. Use the National Electric Code to determine system wiring size (refer to NEC clause 310), type and temperature rating of conductors to be connected to the module's connectors. Wiring connected to the module's wiring should be #12 AWG (minimum) and must be temperature rated at 90°C (minimum).
- ❖ In Canada installation shall be in accordance with CSA C22.1, Safety Standard for Electrical Installations, Canadian Electrical Code, Part 1.
- ❖ The cross section area of cable and the capacity of connector must be selected to suit the maximum system short circuit current, otherwise the cable and connector will be overheated under large current. Refer to NEC for details.
- ❖ Module overcurrent protection, rated for DC use fuses

5.4 Grid Connected Electrical System

- ❖ The DC electrical energy generated by photovoltaic systems may also be converted to AC and connected to a utility grid system. As local utilities' policies on connecting renewable energy systems to their grids vary from region to region, consult a qualified system designer or integrator to design such a system. Permits are normally required to install such a system and the utility must formally approve and inspect such a system before it can be connected to the grid.

6. Commission and Maintenance

Renogy recommends that all work in commissioning and maintenance of a system must be performed by a qualified solar PV technician!

6.1 Testing, Commissioning, and Troubleshooting

- ❖ Test all electrical and electronic components of your system before commissioning it. Follow the instructions in the guides supplied with the components and equipment.
- ❖ Testing modules connected in series before they are connected to system.
- ❖ To determine Voc and Isc in the following tests, the module(s) must be exposed to the sun and not connected to a load. Observe personal safety when making these measurements.
- ❖ Check the open-circuit voltage (Voc) of every series module using a digital multimeter (Fluke 170 series are recommended). The measured system Voc should correspond to the sum of the Vocs of the individual module. You will find the rated voltage in the technical specifications of the type of the module used and in the tables at the end of this Installation Guide. If the measured value is significantly lower than the expected value, proceed as described under "Troubleshooting an excessively low voltage".
- ❖ Determine the short-circuit current (Isc) of every series circuit. It can be measured directly by connecting the digital multimeter connected in the two terminals of series circuit or module, Attention, the rated scale of the ammeter or the rated current of load should more than 1.25 times than the rated short-circuit current of series module. You will find the rated current in the technical specifications of the type of module used. The measured value can vary significantly, depending on weather conditions, the time of day and shading of the module.

To identify the commonly low voltage and excessively low voltage, the commonly low voltage mentioned here is the decrease of open-circuit voltage of the module, which is caused by the temperature rising of solar cells or lower irradiance. Excessively low voltage is typically caused by improper connections at the terminals or defective bypass diodes.

- ❖ First, check all wiring connections to make sure it is not open-circuit or is not connection well.
- ❖ Check the open-circuit voltage of each module:
- ❖ Fully cover the modules with an opaque material.
- ❖ Disconnect the wiring at both terminals of the modules.
- ❖ Remove the opaque material from the module to be checked and measure the open-circuit voltage at its terminals.
- ❖ If the measured voltage is only half of the rated, this indicates a defective bypass diode. Refer to 'Testing and replacing bypass diodes'.

- ❖ In the case of not very low irradiance, if the voltage across the terminals differs from the rated value by more than 5 percent, this indicates a bad electrical connection.

6.2 Maintenance

Renogy recommends the following maintenance in order to ensure optimum performance of the module:

- ❖ Clean the glass surface of the module as necessary. Always use water and a soft sponge or cloth for cleaning. A mild, non-abrasive cleaning agent can be used to remove stubborn dirt.
- ❖ Check the electrical and mechanical connections every six months to verify that they are clean, secure and undamaged.
- ❖ If any problem arises, have them investigated by a competent specialist. Observe the maintenance instructions for all components used in the system, such as support frames, charging regulators, inverters, batteries, etc.

6.3 Replacing Bypass Diodes

Removing the bypass diodes should be done only by a competent PV technician and after the module has been disconnected from the system.

- ❖ Place module face down on a soft, flat surface. Insert a 3mm flat screwdriver into the slot on the junction box cover. (The cover has a sign of screwdriver). Gently pull up the four slots until the cover has been opened.
- ❖ Insert the 3mm flat screwdriver into a hole alongside of diode and near one mounting hole of the diode, pry the screwdriver in the opposite direction of diode and gently pull the diode up until the lead comes free. Do the same in the other mounting hole of the diode, and repeat until the diode is free.
- ❖ Note the orientations of the polarity markings on the diodes.
- ❖ Check the resistance of the diodes by using the digital multimeter's ohms scale. Resistance should be low in one direction, then when leads are reversed on the diode's terminals the resistance should be high, as illustrated in the two pictures below. If a diode has a low resistance in both directions, it is probably shorted. If it has high resistance in both directions it is probably open. In either case it should be replaced.
- ❖ Replace a defective diode with a diode of the same type, and ensure that its polarity marking is oriented the same way as the original diode.
- ❖ Finally, check the open-circuit voltage (Voc) of the module, as described previously, and replace both covers.