

# REGO

## MPPT Solar Charge Controller

12V | 60A

VERSION A1



# QUICK GUIDE

# Contents

Package Contents.....	01
Wiring Diagram.....	02
Product Overview.....	03
Installation.....	04
Communication.....	15
Operation & Maintenance.....	18



# Package Contents

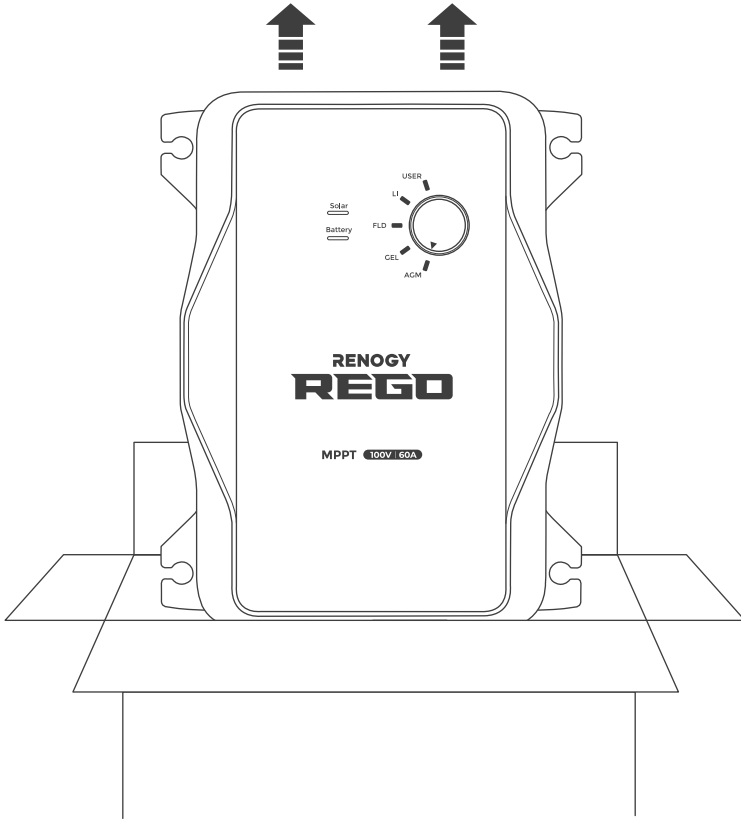

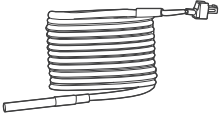
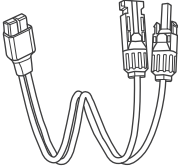
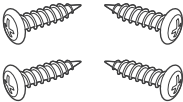
Quick Guide × 1	Renogy Temperature Sensor × 1 (Model: RTSCC)	Solar Adapter Cable ( Anderson PP75 to MC4 Adapter Cable )	Mounting Screws × 4
			ST6.3x1.8x13mm 



# Wiring Diagram

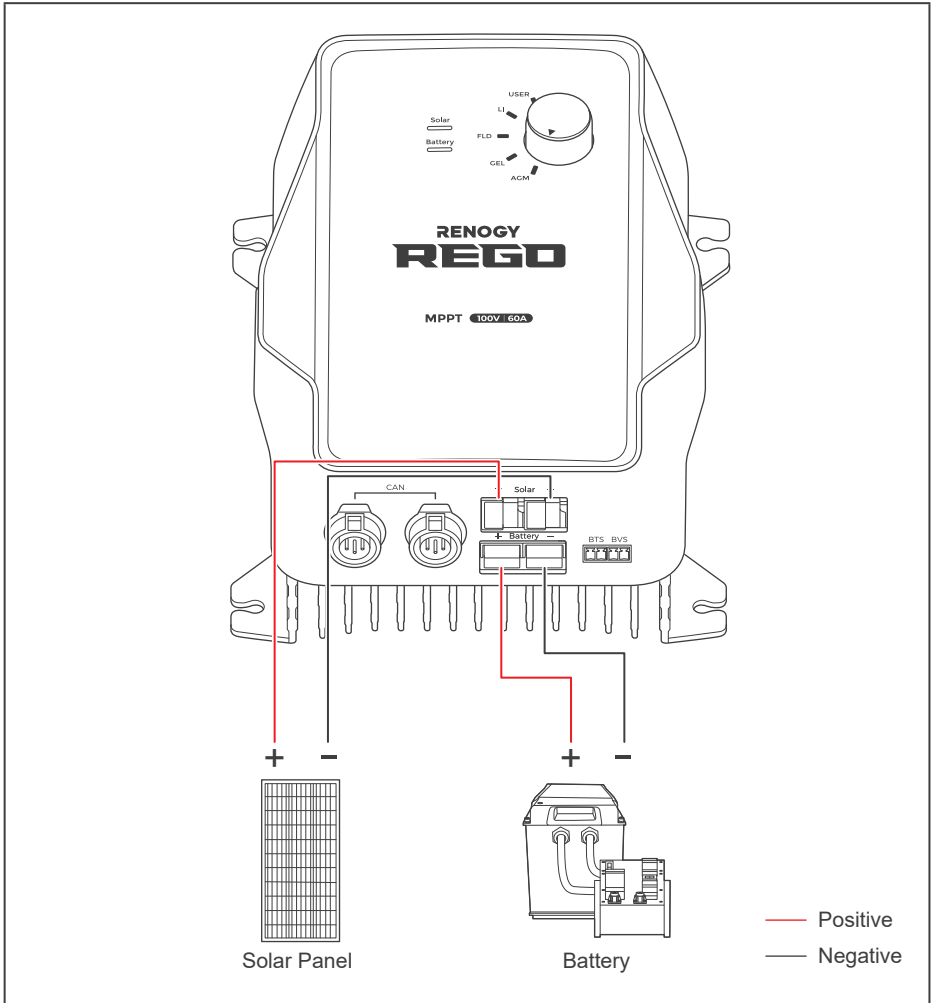

- This Quick Guide contains important installation, operation, and maintenance instructions for REGO 12V 60A MPPT Solar Charge Controller. Please read the Quick Guide carefully before using.
- Illustrations in the Quick Guide are for reference only.
- For more detailed instructions, please refer to the user manual at [renogy.com](http://renogy.com).
- For additional support, please contact our customer service through [renogy.com/contact-us/](http://renogy.com/contact-us/).



# Product Overview

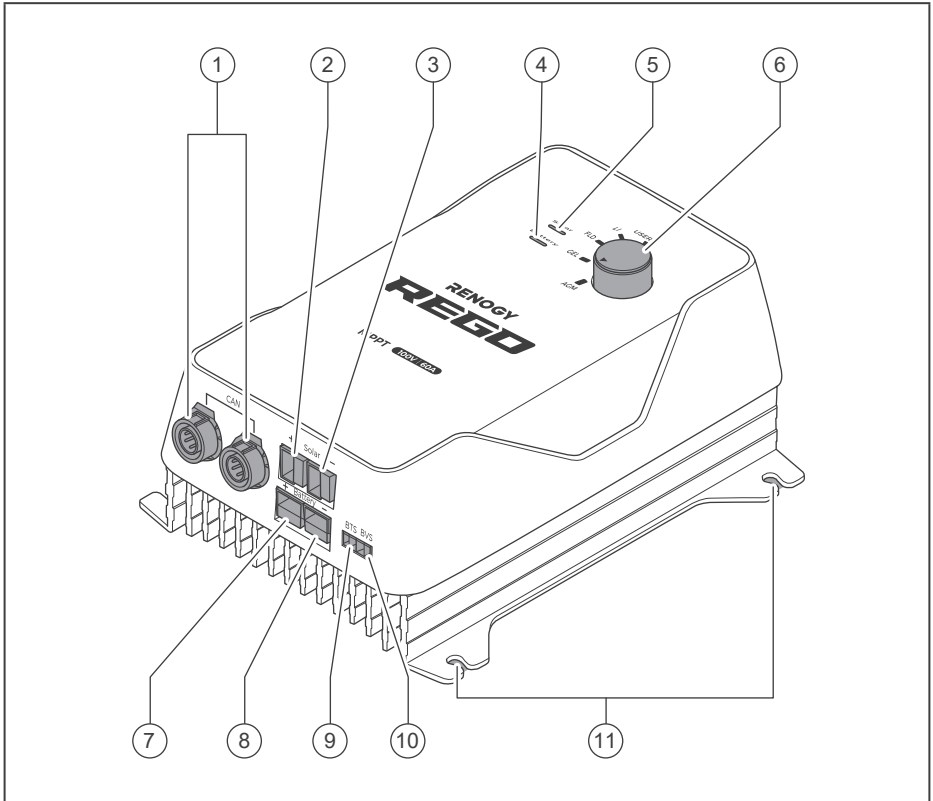

No.	Part	No.	Part
1	CAN Communication Ports	7	Positive Battery Terminal
2	Positive Solar Terminal	8	Negative Battery Terminal
3	Negative Solar Terminal	9	Battery Temperature Sensor Port
4	Battery Status Indicator	10	Battery Voltage Sensor Port
5	Solar Status Indicator	11	Mounting Holes
6	Battery Type Setting Knob		



- Please inspect the charge controller for any visible damage including cracks, dents, deformation, and other visible abnormalities before installation.
- There are no user serviceable parts inside the charge controller. Do not disassemble or attempt to repair it.



# Installation

## Recommended Components

Battery Scenario A: REGO Battery Kit

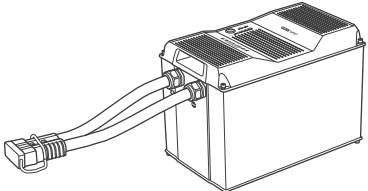
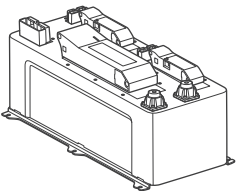
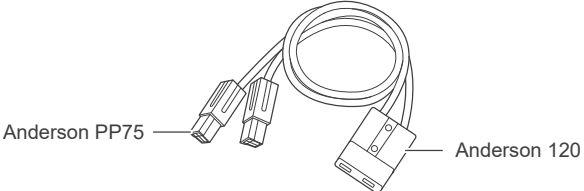
REGO 12V 400Ah Lithium Iron Phosphate Battery	REGO 4 Ports 400A System Combiner Box
	
Battery Adapter Cable ( Anderson PP75 to Anderson 120 Adapter Cable )	
 <p>Anderson PP75 — Anderson 120</p>	

Battery Scenario B: Normal Battery Kit

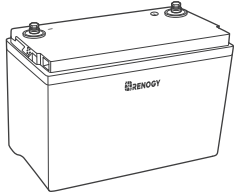
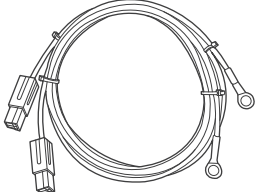
Normal Battery with +/- Bolts	Battery Adapter Cables ( Anderson PP75 to Ring Terminal Adapter Cable )
	

Solar Panel Kit

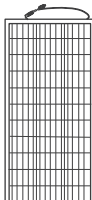
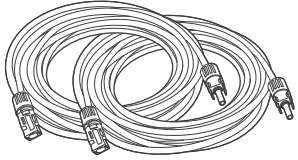
Solar Panel	Solar Panel Extension Cables
	



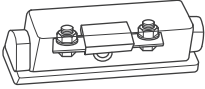
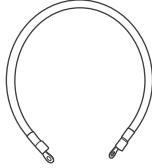
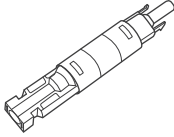
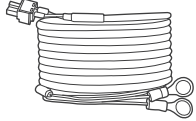

# Installation

## \*Optional Accessories

*Battery Fuse	*Fuse Cable	*Solar Panel In-line Fuse	*Battery Voltage Sensor (Model: RVSCC)
			

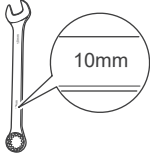
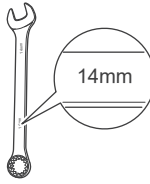
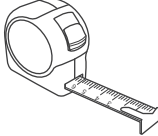
## Required Tools

Wrench (10mm)	Wrench (14mm)	Measuring Tape	Insulation Tape
			



# Installation

## Mounting Location



- Risk of explosion! Never install the charge controller in a sealed enclosure with flooded batteries! Do not install in a confined area where battery gases can accumulate.
- Place the charge controller on a vertical surface protected from direct sunlight, high temperatures, and water. Make sure there is good ventilation.
- The charge controller requires at least 6 inches (150mm) of clearance above and below for proper air flow. Ventilation is highly recommended if mounted in an enclosure.
- If the Battery Adapter Cable or Solar Panel Extension Cable is not long enough, you can use more extension cables or reselect the position where the charge controller needs to be secured.

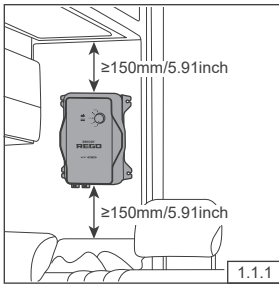

Confirm the installation location.

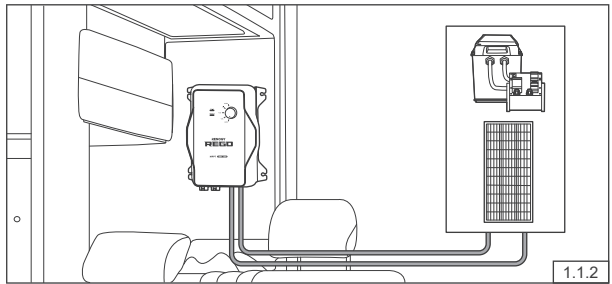

Measure the length of the cables connecting to the battery and solar panel so they can be connected to the charge controller.





# Installation

## Charge Controller Wiring



- Please refer to the user manual of the charge controller at [renogy.com](http://renogy.com) for the recommended wire gauge and length.
- Please make sure that the connections of the Anderson connectors are tight and secure.

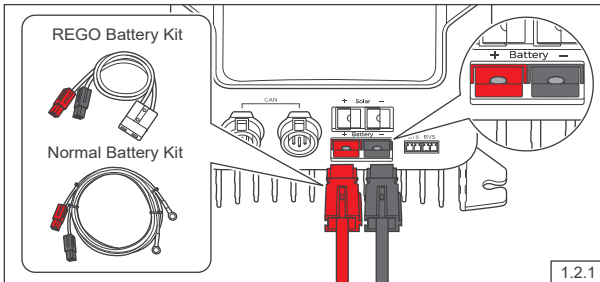

For the Battery terminal, align the Battery Adapter Cable's Anderson PP75 connectors to the correct orientation and polarity.

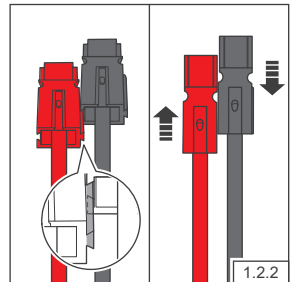

Bind the Anderson connectors by sliding the side grooves.

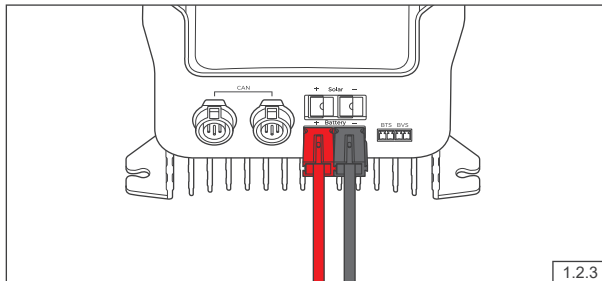

Insert the Anderson connectors into the Battery terminal.

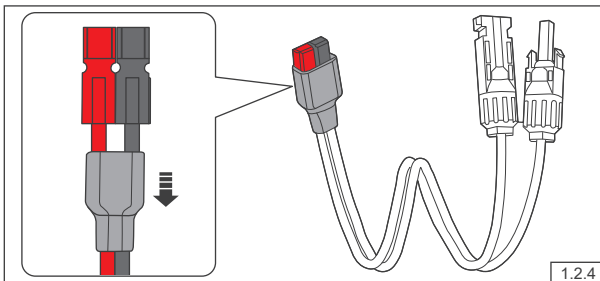

Remove the protective cover of the Solar Adapter Cable by sliding it downwards.



# Installation

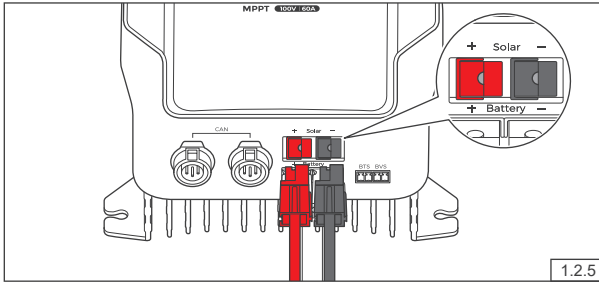

For the Solar terminal, align the Solar Adapter Cable's Anderson PP75 connectors to the correct orientation and polarity.

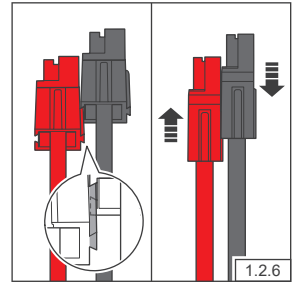

Bind the Anderson connectors by sliding the side grooves.

Push the protective cover upwards.

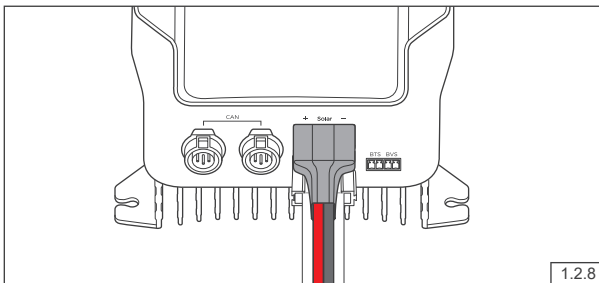
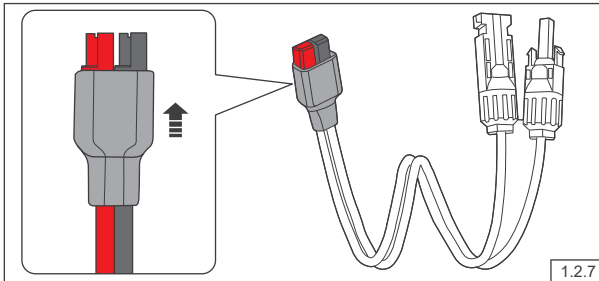

Insert the Anderson connectors into the Solar terminal.



# Installation

## Battery Wiring



- Please read the user manual of the battery (12V) carefully before installation.
- Identify the polarity (positive and negative) on the cables used for the batteries. A reverse polarity contact may damage the unit.
- Select a suitable wrench or other tool when tightening the battery bolts to their rated specification.
- Please ensure that the Anderson Connectors are fully seated and/or the ring terminals are securely connected.

### Battery Scenario A: REGO Battery Kit



- Please read the user manual of REGO 4 Ports 400A System Combiner Box carefully before wiring.
- If the devices are connected to the Anderson connectors of the System Combiner Box, please install a 160A NH fuse in the top NH fuse disconnect switch.
- If the Anderson PP75 to Ring Terminal Adapter Cable is used to connect with the System Combiner Box, please refer to the user manual of REGO MPPT Solar Charge Controller at [renogy.com](http://renogy.com) for more detailed instructions.
- If positive/negative busbars are used to connect with the Renogy REGO Lithium Battery, please refer to the user manual of REGO MPPT Solar Charge Controller at [renogy.com](http://renogy.com) for more detailed instructions.

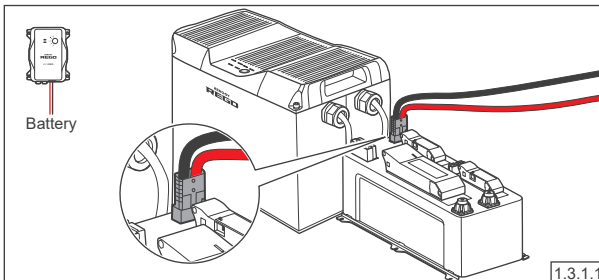

Insert the Anderson 120 connector of the Battery Adapter Cable to the System Combiner Box.



# Installation

## Battery Scenario B: Ordinary Battery Kit

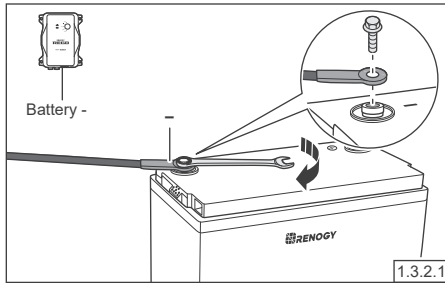

Attach the ring terminal of the negative Battery Adapter Cable to the negative battery bolt and tighten with a wrench.

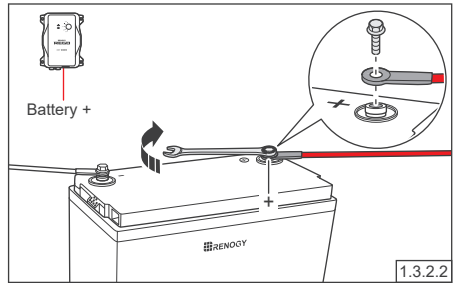

Attach the ring terminal of the positive Battery Adapter Cable to the positive battery bolt and tighten with a wrench.

For your safety, it is recommended to use a battery fuse.



- Please refer to the user manual of the charge controller at [renogy.com](http://renogy.com) for the recommended fuse.

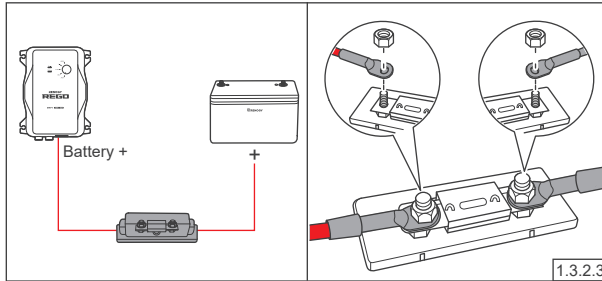

Connect the positive Battery Adapter Cable to one end of the battery fuse, and then connect the other end to the positive bolt of the battery.

## Battery Indicator

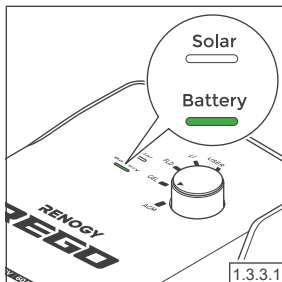

Once the battery wiring is completed correctly and the battery is turned on, the charger controller's Battery indicator lights up green.

If the Battery indicator does not light up, please refer to the user manual of the charge controller at [renogy.com](http://renogy.com) for troubleshooting instructions.



# Installation

## Solar Panel Wiring



- Please read the user manual of the solar panel carefully before installation.
- Cover the solar panels or have them face down before connecting them to the charge controller.
- Identify the polarity (positive and negative) on the cables used for solar panels. A reverse polarity contact may damage the unit.
- Make sure all connections are tight and secure.
- Please ensure that the solar panels output current does not exceed 50A, output power does not exceed 800W, and output voltage does not exceed 100V.

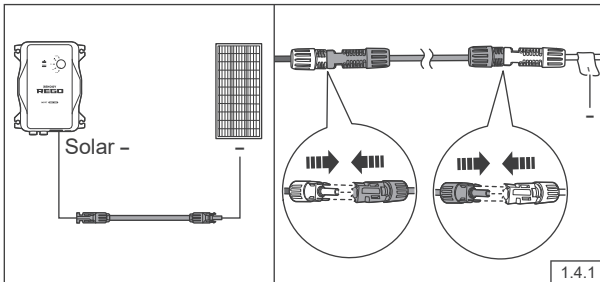

Connect the negative Solar Adapter Cable to the Solar Panel Extension Cable, and then connect the Extension Cable to the negative terminal of the solar panel.

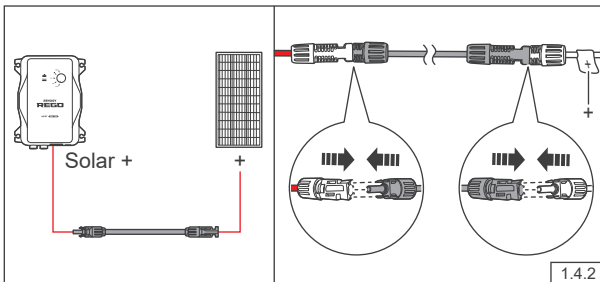

Connect the positive Solar Adapter Cable to the Solar Panel Extension Cable, and then connect the Extension Cable to the positive terminal of the solar panel.

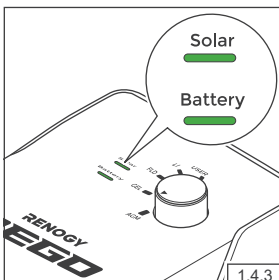

Once the solar panel wiring is completed correctly, the charger controller's Solar indicator lights up green.

If the Solar indicator does not light up, please refer to the user manual of the charge controller at [renogy.com](http://renogy.com) for troubleshooting instructions.



# Installation

For your safety, it is recommended to use a solar panel in-line fuse.



- Please refer to the user manual of the charge controller at [renogy.com](http://renogy.com) for the recommended fuse.

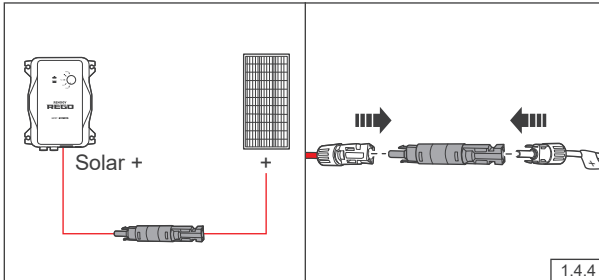

Insert the Solar Panel In-line Fuse between the Solar Adapter Cable and the solar panel's positive cable.

## Mounting



- Please make sure that the charge controller is installed firmly to prevent it from falling off.

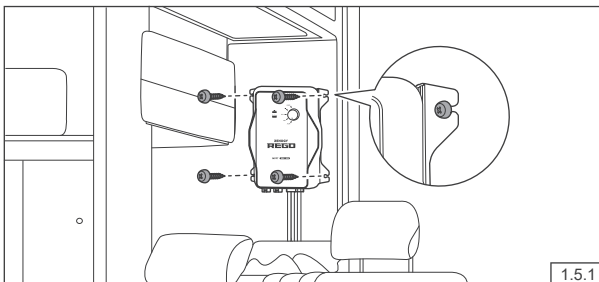

Place the charge controller against a flat surface and secure it with included screws.



# Installation

## Temperature Sensor



- The temperature sensor can detect the battery's temperature and update it to the charge controller for charging voltage calibration. This ensures the charger controller (with operating temperature range from  $-20^{\circ}\text{C}$  to  $60^{\circ}\text{C}$  or  $-4^{\circ}\text{F}$  to  $140^{\circ}\text{F}$ ) can charge the battery normally.
- Do not use the temperature sensor on a LiFePO4 (LFP) battery which comes with a battery management system (BMS).
- Please refer to the user manual of the charge controller at [renogy.com](http://renogy.com) for more matters needing attention.

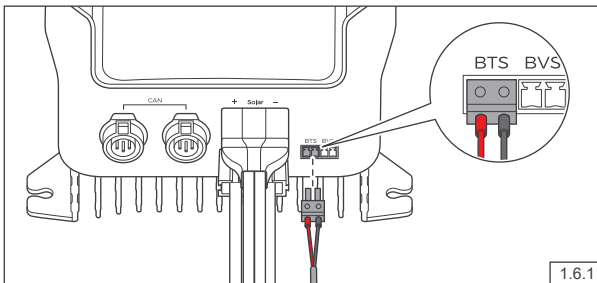

Insert the temperature sensor terminal block into the BTS port of the charge controller.

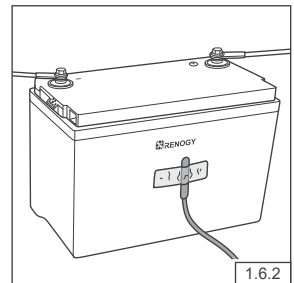

Adhere the sensor on the top or side of the battery with insulation tape.



# Installation

## \*Voltage Sensor (Optional)

The Battery Voltage Sensor is the perfect solution by providing an accurate battery voltage to the charge controller and allowing it to adjust the charging stage precisely resulting in overall extension of your battery life.



- Identify the polarity (positive and negative) on the cables used for the batteries. A reverse polarity contact may damage the unit.
- The voltage sensor ring terminal is M8 (Approx. 5/16"). If the battery bolt size is small, please use a gasket to fix it to prevent it from falling off.

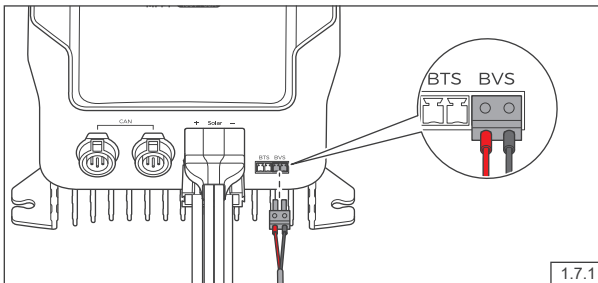

Insert the voltage sensor terminal block to the BVS port.

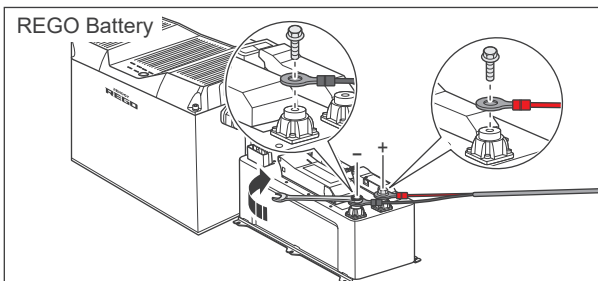

Connect the voltage sensor ring terminal to the positive/negative pole of the battery system.

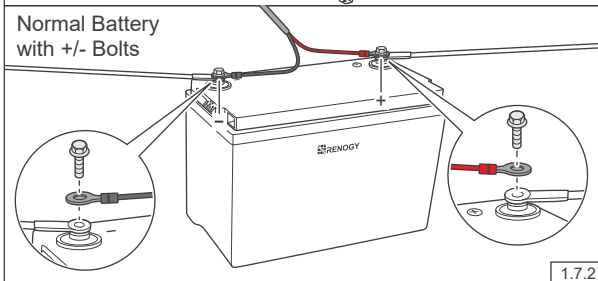





# Communication

The communication connection is optional. It allows the charge controller to communicate with other REGO devices and monitoring devices, enabling safe operation, smart control, remote monitoring, and programmable settings.

## Inter-Device Communication

Depending on the installation condition, the RV-C communication connections between the charge controller and other REGO devices can be established with backbone or daisy chain topology. The inter-device communication allows the charge controller to dynamically adjust the charging profile for an optimal and safe charge.

### Backbone Topology

If an RV-C bus is pre-installed in the RV, check the network wiring diagram provided by the RV manufacturer and follow the backbone topology for the RV-C communication connections. Refer to the user manual of the charge controller at [renogy.com](http://renogy.com) for more details.

### Daisy Chain Topology

If the RV-C bus is not available, follow the daisy chain topology for the communication connections.

### Recommended Accessories

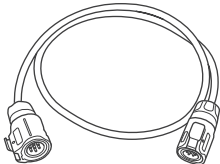
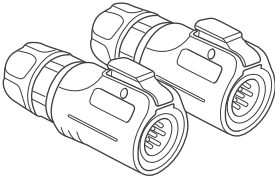
LP16 Plug (7-Pin) Communication Cable	LP16 Terminator Plug (7-Pin)
	

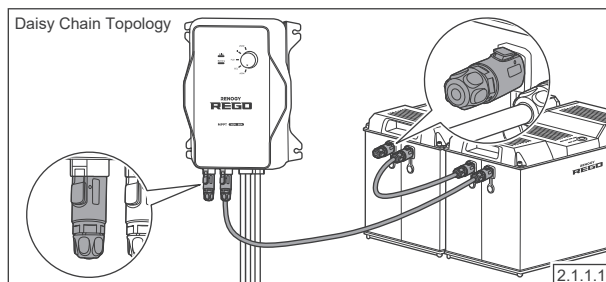

Connect the charge controller to other REGO devices in series through either of the CAN Communication Ports with the Communication Cables (sold separately).

Plug the Terminator Plug (sold separately) into the free CAN Communication Ports on the first and last REGO devices.



# Communication

## Monitoring Device Communication

Depending on the application, the short-range or long-range communication connections can be established between the charge controller and the monitoring devices. The monitoring device communication allows for the monitoring and programming of the charge controller or even the complete system.



- Please scan the QR code on the last page of the Quick Guide to download the DC Home app.
- Please make sure that the charge controller is turned on before the connection.

### Short-Range Monitoring

If only short-range monitoring is required, connect the charge controller to the DC Home app directly through Bluetooth.

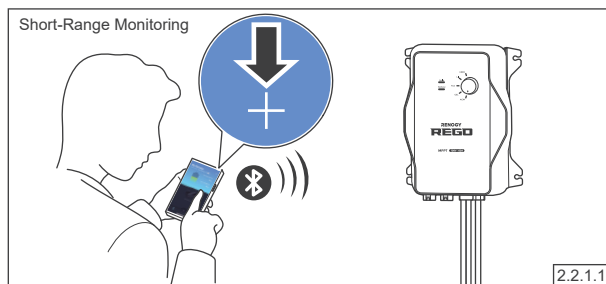

Click "+" to search for new devices. Add the newly found charge controller to the device list. Monitor the charge controller on the device page.

### Long-Range Monitoring

If long-range communication and programming are required, connect the charge controller to Renogy ONE through Bluetooth or hard wire, and the Renogy ONE to the DC Home app through WiFi or cellular network.



- Please make sure that the Renogy ONE is powered on before the connection.
- Please read the user manual of Renogy ONE at [renogy.com](http://renogy.com) before the connection.

### Recommended Accessories

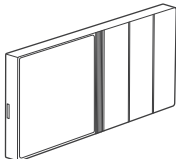
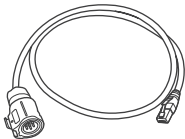
Renogy ONE	LP16 Plug (7-Pin) to RJ45 Communication Adapter Cable
	



# Communication

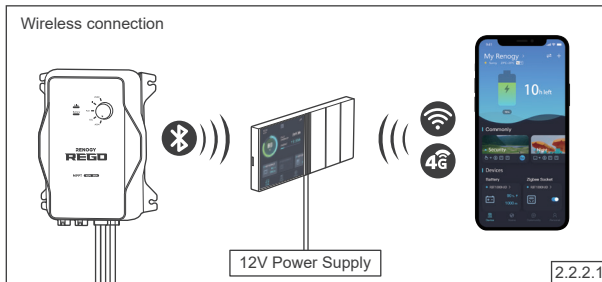

If the inter-device communication is not established, connect the charge controller to the Renogy ONE (sold separately) through Bluetooth, and the Renogy ONE to the DC Home app through WiFi or cellular network. Monitor the charge controller on the Renogy ONE or the DC Home app.

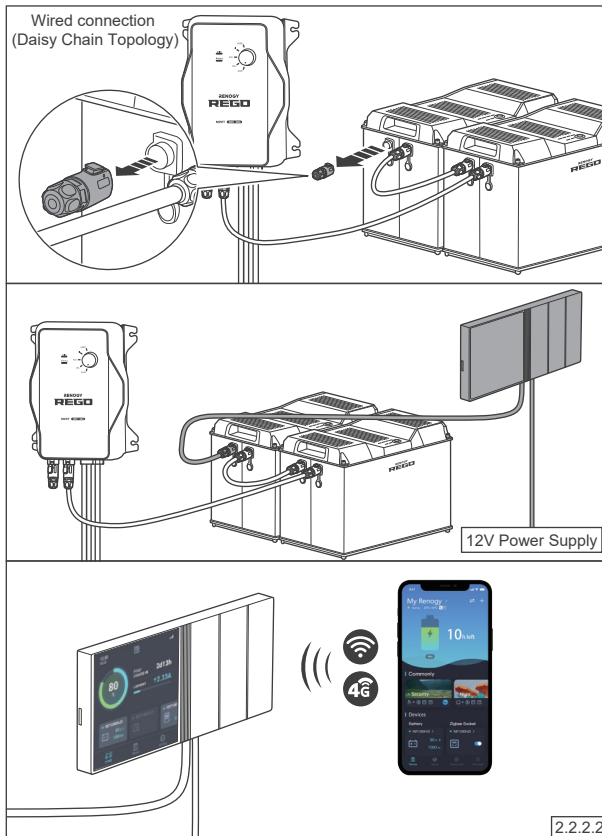

If the inter-device communication is established with the backbone topology, connect the Renogy ONE to the RV-C bus. Contact the RV manufacturer for more details before the connection.

If the inter-device communication is established with the daisy chain topology, remove the Terminator Plug from the REGO device at either end of the daisy chain and connect the Renogy ONE to the free CAN Communication Port on the REGO device with the Communication Adapter Cable (sold separately).

Connect the Renogy ONE to the DC Home app through WiFi or cellular network. Monitor and program the complete system on the Renogy ONE or the DC Home app.



# Operation & Maintenance

## Operation

The charge controller is simple and easy to use. The plug & play design makes the installation easier, and the knob with 5 gears makes the selection of battery type more convenient.

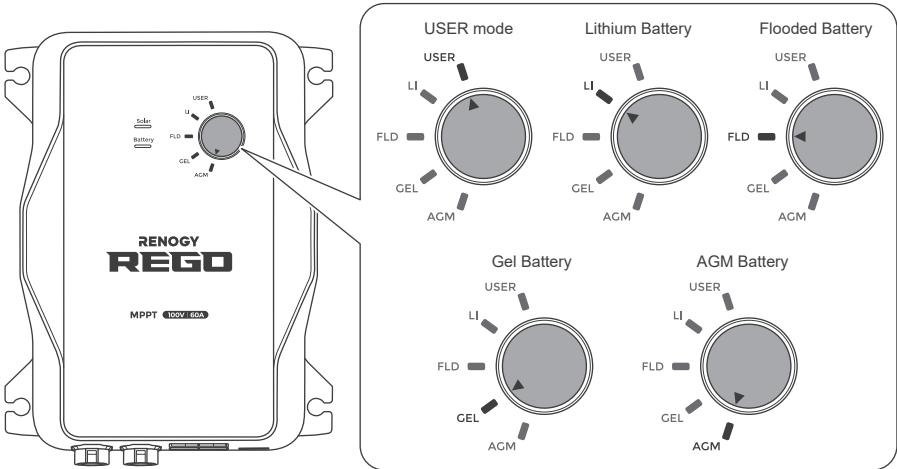

User Mode requires the addition of the Renogy DC Home app customize charge parameters. Please scan the QR Code on the last page of the Quick Guide to download the app.

## Maintenance

For optimum performance, it is recommended to perform these tasks regularly.

- Ensure the charge controller is mounted in a clean, dry, and ventilated area.
- Ensure there is no damage or wear on the cables.
- Ensure the firmness of the Anderson connectors and check if there are any loose, damaged or burnt connections.
- Make sure that the Battery indicator and Solar indicator are in normal state.
- Ensure there is no any corrosion, insulation damage, or discoloration marks of overheating or burning.



- Risk of electric shock! Make sure that all power is turned off before touching the terminals on the charge controller.
- Please refer to the user manual of the charge controller at [renogy.com](http://renogy.com) for more details.

## FCC Statement

This device complies with Part 15 of the FCC Rules. Operation is subject to the following two conditions:

- (1) This device may not cause harmful interference, and
- (2) This device must accept any interference received, including interference that may cause undesired operation.

This equipment has been tested and found to comply with the limits for a Class B digital device, pursuant to Part 15 of the FCC Rules. These limits are designed to provide reasonable protection against harmful interference in a residential installation. This equipment generates uses and can radiate radio frequency energy and, if not installed and used in accordance with the instructions, may cause harmful interference to radio communications. However, there is no guarantee that interference will not occur in a particular installation. If this equipment does cause harmful interference to radio or television reception, which can be determined by turning the equipment off and on, the user is encouraged to try to correct the interference by one or more of the following measures:

- (1) Orient or relocate the receiving antenna.
- (2) Increase the separation between the equipment and receiver.
- (3) Connect the equipment into an outlet on a circuit different from that to which the receiver is connected.
- (4) Consult the dealer or an experienced radio/TV technician for help.

## FCC Radiation Exposure Statement

This equipment complies with FCC radiation exposure limits set forth for an uncontrolled environment. This equipment should be installed and operated with minimum distance 20cm between the radiator & your body.



## Renogy Empowered

Renogy aims to empower people around the world through education and distribution of DIY-friendly renewable energy solutions.

We intend to be a driving force for sustainable living and energy independence.

In support of this effort, our range of solar products makes it possible for you to minimize your carbon footprint by reducing the need for grid power.



## Live Sustainably with Renogy

Did you know? In a given month, a 1KW solar energy system will...



Save 170 pounds of coal from being burned



Save 300 pounds of CO<sub>2</sub> from being released into the atmosphere



Save 105 gallons of water from being consumed



## Renogy Power **PLUS**

Renogy Power Plus allows you to stay in the loop with upcoming solar energy innovations, share your experiences with your solar energy journey, and connect with like-minded people who are changing the world in the Renogy Power Plus community.

Also, follow us on Social Media @RenogySolar.

Visit [renogy.com](http://renogy.com) to find the User Manual or get more support via "Contact Us".  
Renogy reserves the right to change the contents of this manual without notice.

Manufacturer: RENOGY New Energy Co.,Ltd  
Address: No.66, East Ningbo Road Room 624-625  
Taicang German Overseas Students Pioneer Park  
JiangSu 215000 CN



eVatmaster Consulting GmbH  
Battinastr.30  
60325 Frankfurt am Main, Germany  
[contact@evatmaster.com](mailto:contact@evatmaster.com)

Manufacturer: RENOGY New Energy Co.,Ltd  
Address: No.66, East Ningbo Road Room 624-625  
Taicang German Overseas Students Pioneer Park  
JiangSu 215000 CN



EVATOST CONSULTING LTD  
Suite 11, First Floor, Moy Road Business  
Centre, Taffs Well, Cardiff, Wales, CF15 7QR  
[contact@evatmaster.com](mailto:contact@evatmaster.com)

Your voice matters! Scan the QR code to  
submit your feedback on the product.



Welcome to join Renogy Power **PLUS** Community  
by scanning the QR code to install DC Home app.  
Find your e-warranty here, and more.

