

The Renogy Firefly

20W Portable Solar System



RENOGY

THE FUTURE OF CLEAN ENERGY

2775 E. Philadelphia St., Ontario CA 91761

1-800-330-8678

Important Safety Instructions

Please save these instructions.

This manual contains important safety, installation, and operating instructions for the power unit. The following symbols are used throughout the manual to indicate potentially dangerous conditions or important safety information.

⚠ WARNING: Indicates a potentially dangerous condition. Use extreme caution when performing this task.

CAUTION: Indicates a critical procedure for safe and proper operation of the unit.

NOTE: Indicates a procedure or function that is important to the safe and proper operation of the unit.

- Read all of the instructions and cautions in the manual. Keep them in a safe place.
- Do **NOT** Submerge the unit under water. Although the unit is not waterproof, it is water resistant as long as the accessory door is closed.
- Do **NOT** Store or place the unit near fire or places that can achieve higher temperatures. Doing so may cause damage to the unit internals, and or battery explosion.
- Do **NOT** leave the unit outside when raining.
- Do **NOT** overload the AC or DC outputs. Follow the power and current ratings mentioned earlier in this manual.
- Clean the built-in solar panels when dirty with window cleaner or with a wet cloth.
- Store the unit in a dry place free from moisture, heat, and water.
- Ensure the solar panels are exposed to sufficient light – ideally position them to face the sun directly.
- Only use attachments/accessories specified by the manufacturer.
- Unplug this unit during lightning storms or when not in use.

WARNING: Keep the unit away from small children. Allow only adults to use the unit.

WARNING: Do not dismantle or modify the system. Doing so, can result in damage to the unit and or onto your-self. Any modifications that will alter the device will void the warranty.

WARNING: In case of a hazard or emergency, turn OFF the unit immediately.

Table of Contents

General Information	4
Identification of Parts.....	5
Installation	7
Operation	8
Charging	12
System Status Troubleshooting	15
Technical Specifications	16
Solar Panels.....	16
Built-in Electrical Components.....	16
Accessories.....	16
Physical Properties	16
Dimensions	17

General Information

The Renogy Firefly is specifically designed for mobile, off-grid applications, and is ideal for emergencies. This compact, portable back-up system combines two highly efficient Renogy 10W solar panels, one built-in 10A charge controller, one 150W power inverter, and one 16Ah lithium polymer battery in a robust, waterproof case, creating a simple plug-and-play system.

Key Features

Ease of Use:

- Straightforward LED display with information on battery capacity, errors, and DC/AC load on/off.
- AC and DC output buttons allow for easy switching between the two output modes.

Versatile:

- Various outputs for different devices. It can charge any USB or AC appliance under 150W.

Portable:

- Compact case with a carrying handle. Designed for mobile, off-grid applications.

Emergency:

- Provides up to 175Wh of energy and includes a 3W LED flashlight on the sides of two modes, lighting and SOS.

Expansion:

- Built-in charge controller allows for an additional 12V solar panel:
 - Renogy 10W 12V Monocrystalline Solar Panels
 - Renogy 20W 12V Monocrystalline Solar Panels
 - Renogy 30W 12V Monocrystalline Solar Panels
 - Renogy 50W 12V Monocrystalline Solar Panels
 - Renogy 50W 12V Polycrystalline Solar Panels

Identification of Parts

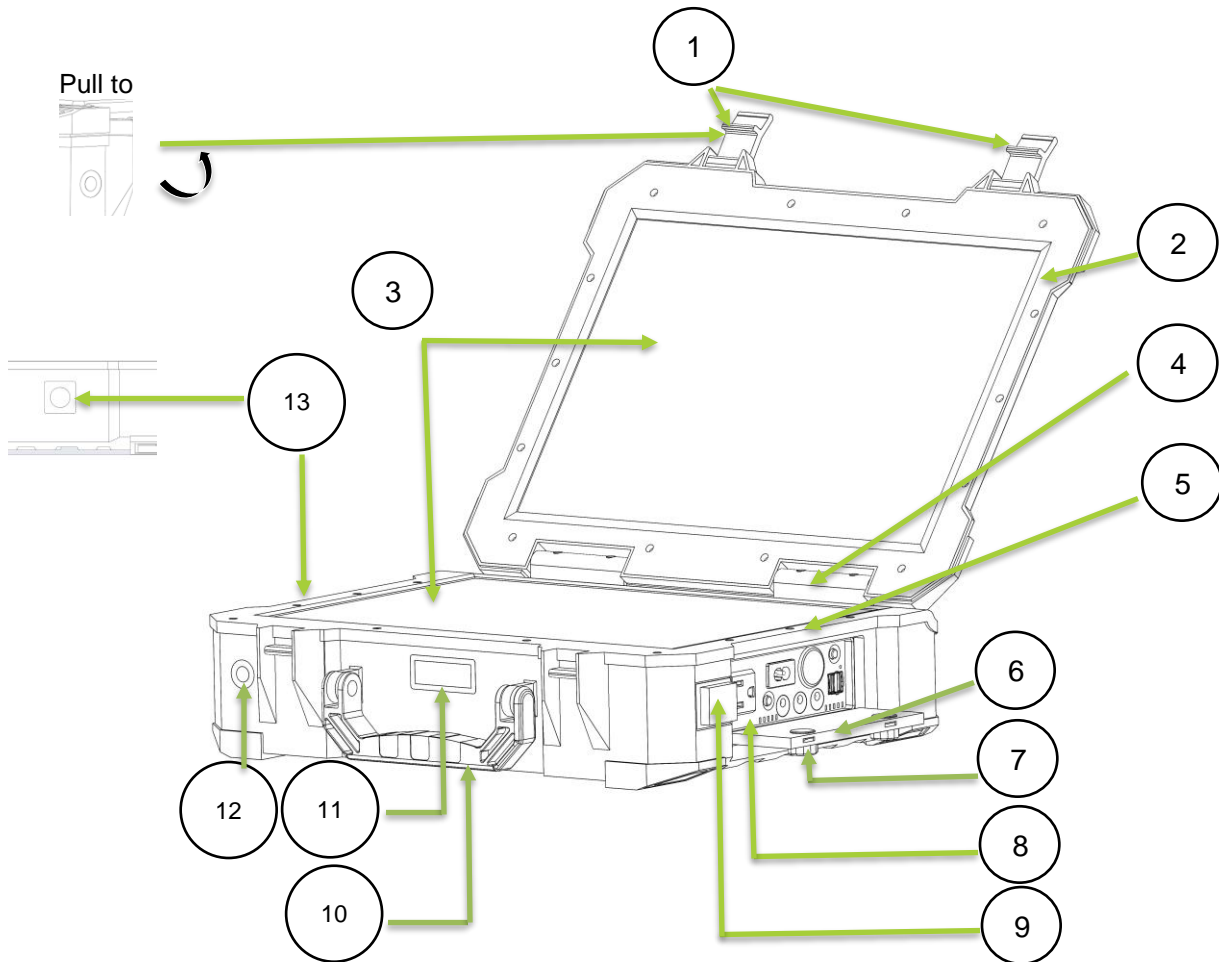

Figure 1. Properties of the 20w Firefly portable solar system

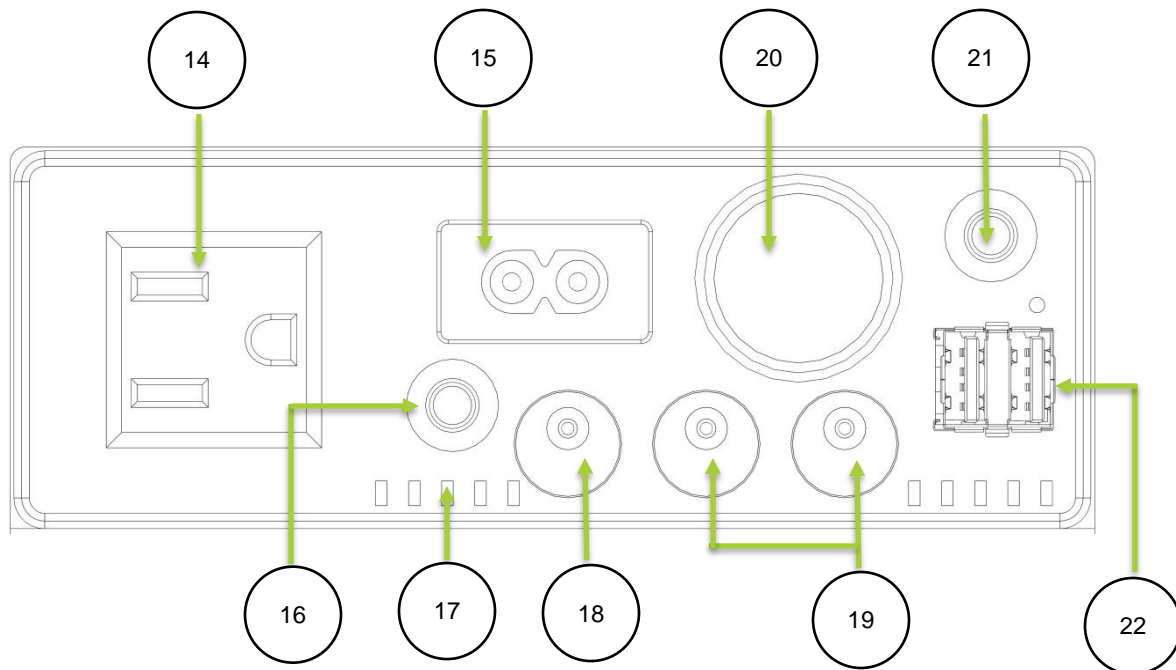

Figure 2. Accessories

Key Parts

1. Latches
2. Top Bezel
3. Solar Panels
4. Hinge
5. Body
6. I/O access door
7. Door lock
8. Gasket
9. Main Switch
10. Handle
11. Display
12. LED Flashlight Switch
13. LED Flashlight
14. AC 110V Output
15. AC 110V Input (2-pin inlet)
16. AC Output Switch
17. Exhaust Vents
18. DC Input (Extra Solar Panel)
19. DC 12V Outputs
20. DC 12V Cigarette Output
21. DC Output Switch
22. 5V USB Outputs

Installation

Connecting to the additional solar panel

To speed up the charging time, a 12V solar panel can be used at the DC input terminal with a maximum of input of **70 Watts**.

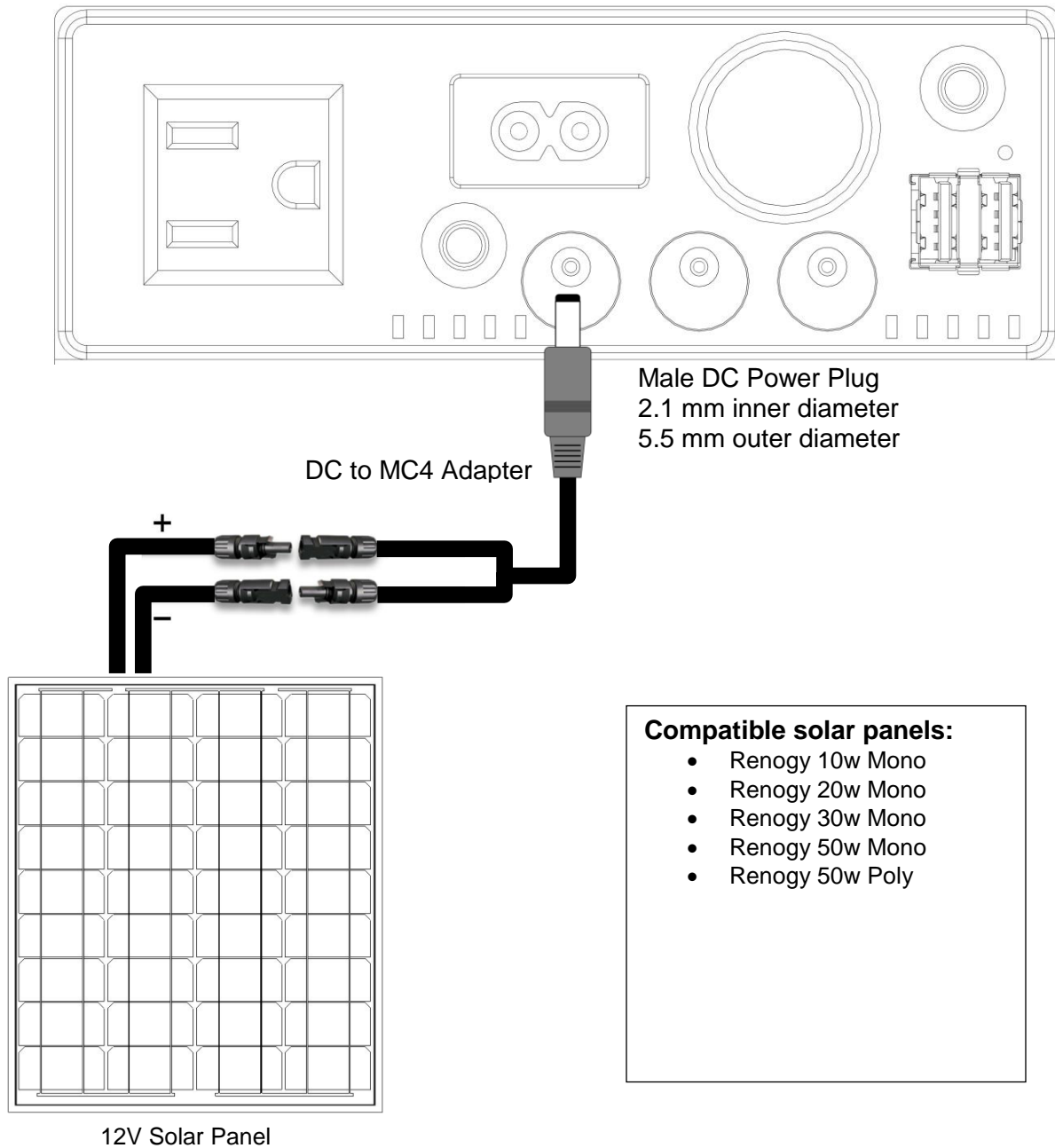
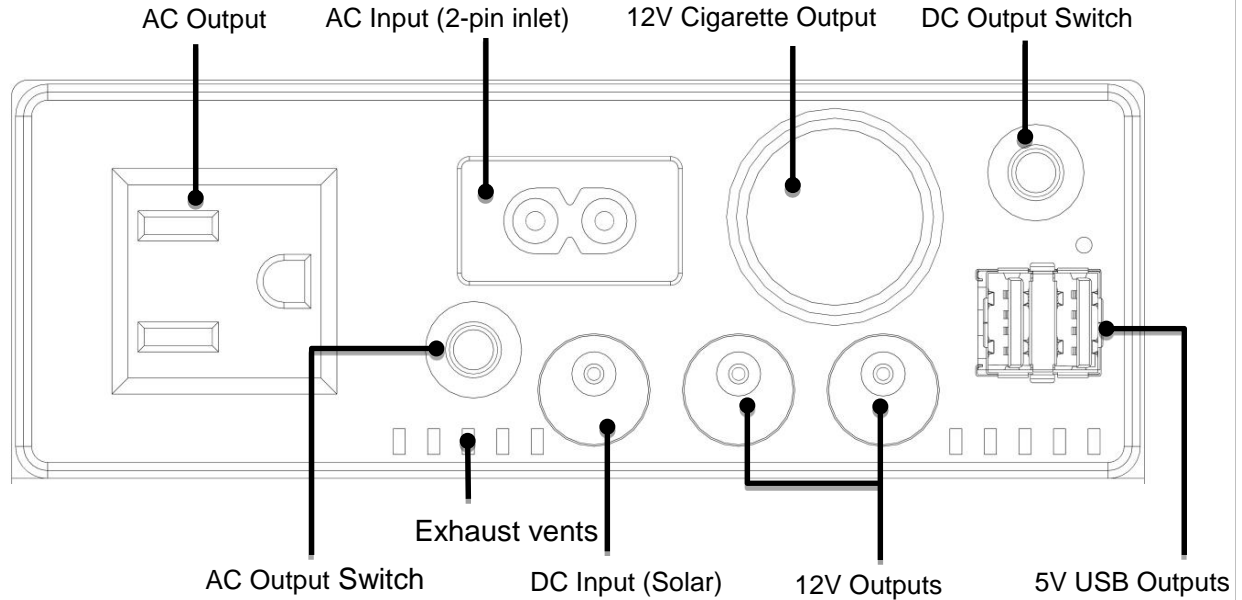

Figure 3. Adding external solar panel

Operation

Accessories

Open the I/O access door by setting the door locks to the “OPEN” position. It is recommended that the unit is placed horizontally as shown in **Figure 1**.



Main Switch

Flip the Main switch to the ON position, this will turn on the digital display.

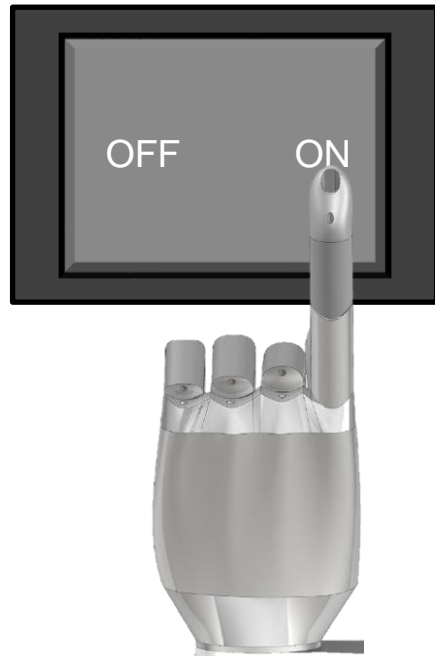

Turn ON the digital display

AC output

Once the Main switch is ON, press the AC output switch to turn the internal inverter on.

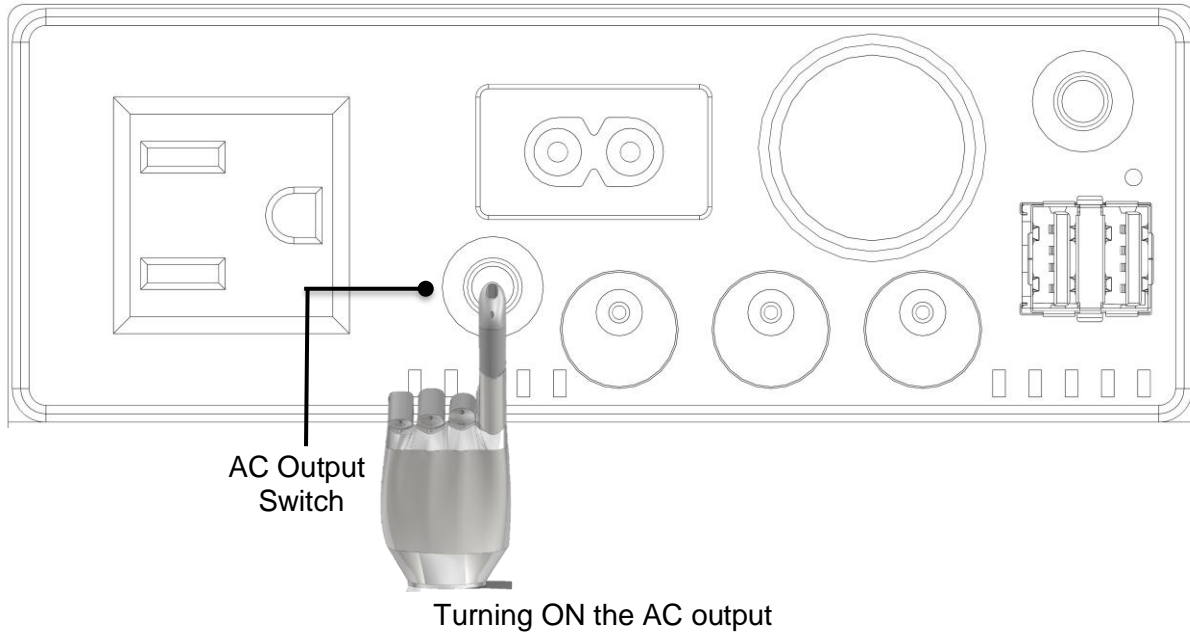

When the AC output is turned ON, the LCD display will light up blue, and “AC OUT” along with the light bulb icon will be shown.

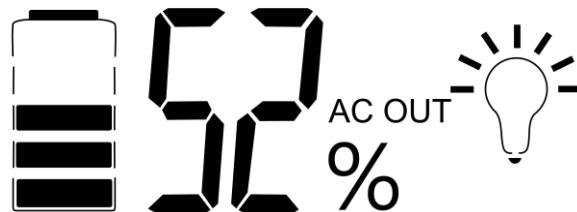

Digital Display when AC output is ON

The AC output can now be used. The maximum load it can handle is **150 Watts**. Please do not overload the output, doing so may damage the unit. Please turn **OFF the AC output** when not in use. Inverters have small idle power consumption, leaving the switch ON will drain the battery over time.

DC output

With Main switch is ON, press the DC output switch to turn the internal inverter on.

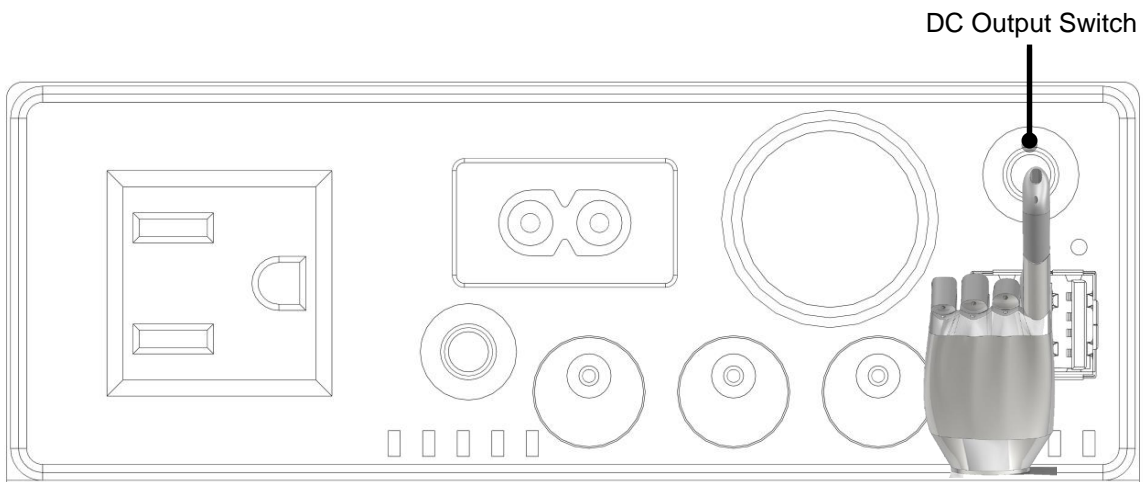

Turning ON the DC output

When the DC output is turned ON, the LCD display will light up blue, and "DC OUT" along with the light bulb icon will be shown.

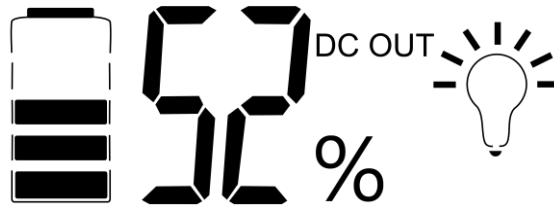

Digital Display when DC output is ON

The DC output can now be used. Please limit the current load for each DC output. Please do not overload the output, doing so may damage the unit. Please turn **OFF the DC output** when not in use. Figure 7 shows the maximum current per DC output.

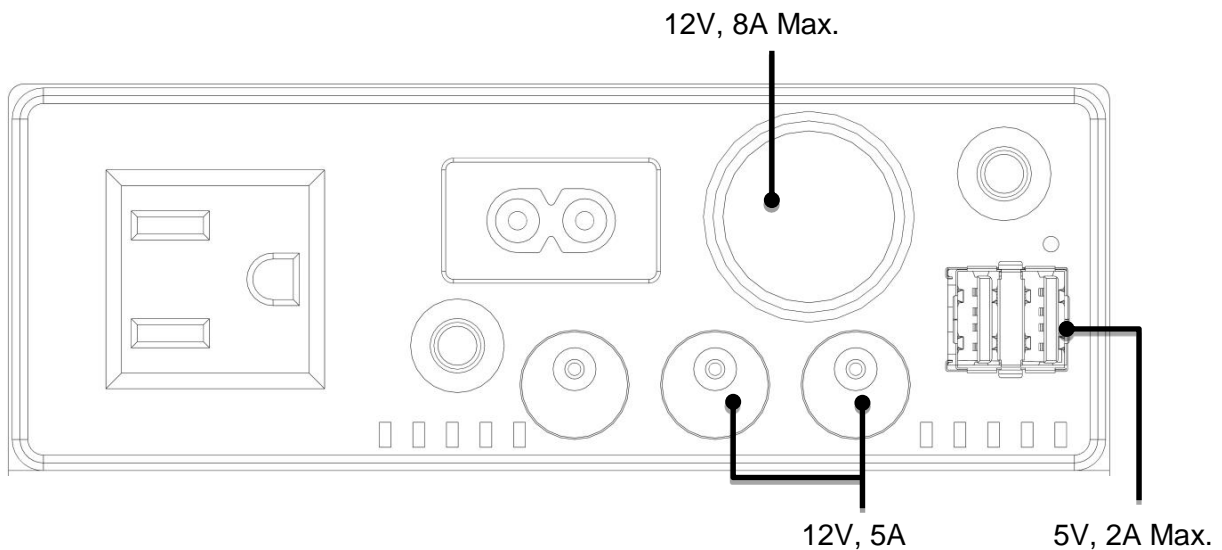

AC and DC outputs

The AC and DC outputs can be ON at the same time. When the Main switch is ON, press the AC output switch and then the DC output switch (or vice versa) to turn both outputs on.

When both outputs are turned ON, the LCD display will light up blue, and “DC OUT” and “AC OUT” along with the light bulb icon will be shown.

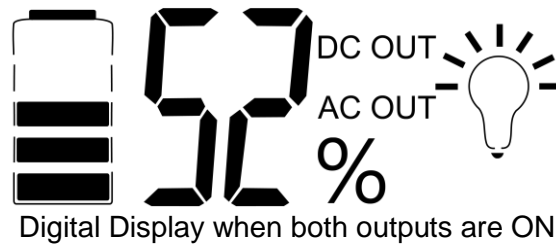

Please turn **OFF the AC and DC outputs** when not in use.

Flashlight

The 20w Firefly portable solar system has a built-in flashlight. To use the flashlight, flip the Main switch to the ON position, this will turn on the digital display.

Then press the flashlight switch located next to the left latch.



The first press on the switch is going to activate **Lighting Mode**. A second press will activate **SOS Mode** (for emergency situations). Finally, a third press will turn **OFF** the flashlight.

Charging

Charging via solar

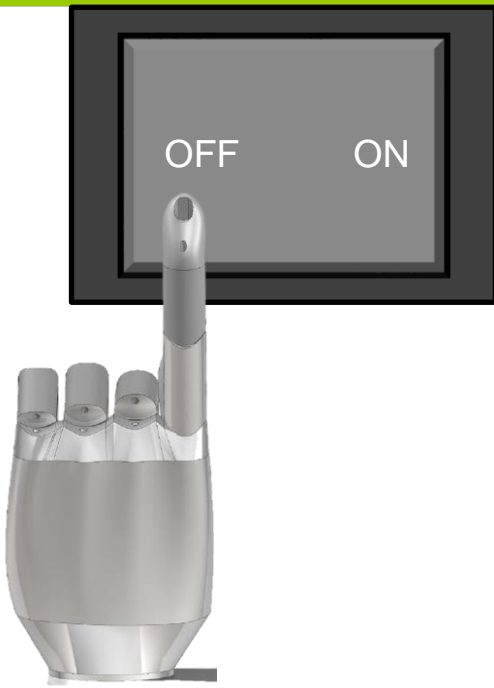

If not planning on using the unit while charging with solar, make sure that the Main switch is in the OFF position.

Find a dry and sunny location that is free from overhanging tree branches, obstructions or shading. Unclip the two latches on the side of the unit and open the top cover completely as shown below.



Charging via solar panels

When charging with the built-in 2x10w solar modules, it will take about **9.5 hours** to fully recharge the internal battery.

Charging with additional solar panels

As shown in **Figure 4**, an additional 12V solar panel can be used at the DC input terminal to speed up the charging time. The specific charging times with different additional panels are as follows.

Additional Solar Panel	Charging Time
10W	6.5 hours
20W	5 hours
30W	4 hours
50W	3 hours

If planning on using the unit while charging with solar, make sure that the Main switch is in the ON position. Then turn ON the desired output. **AC and DC outputs** can also be used while the unit is being charged by solar however, limit the current output to the values mentioned earlier.

Charging via AC

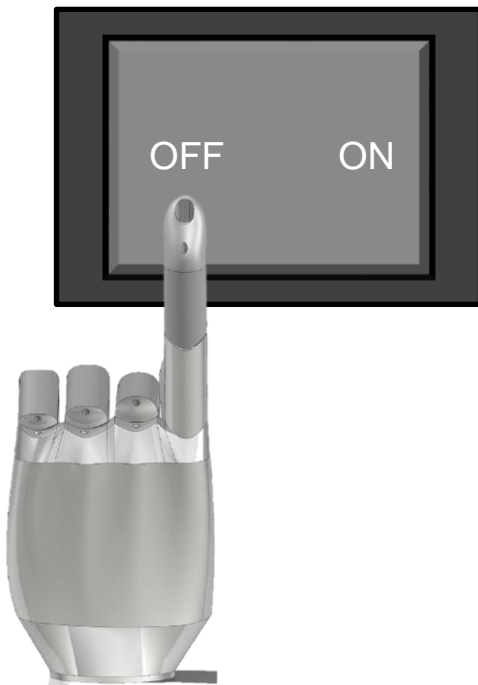

When charging via AC 2-pin inlet, make sure that the Main Switch is in the **OFF** position. It is recommended that when charging via AC input do not use the AC and DC output terminals.

Connect the 2-pin inlet AC cable that is included with the unit. The unit can be charged in vertical or horizontal position. The following figure shows the unit being charged **horizontally** with the AC cable.



It will take about **3 hours** to fully recharge the internal battery. Do not cover or block the exhaust vents when charging with the AC cable. The unit can be **left plugged in** once the battery is fully charged. This will maintain the battery when the unit is not in operation.

State of Charge

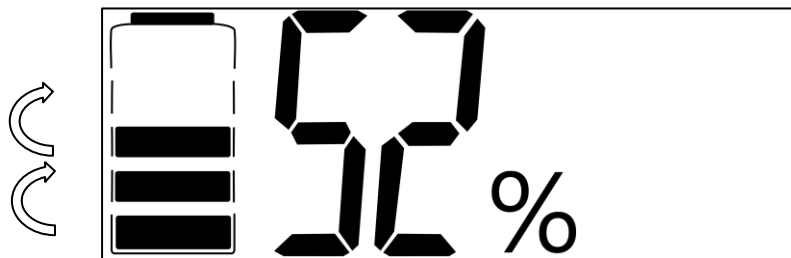

When charging with the solar panel (s) or with AC power, the display will turn on, and after a few seconds the backlight will turn off.



Digital display charging motion

The display will show a “**charging motion**” when charging via solar panel (s) or AC power. The state of charge is shown by percentage, and by the battery icon. Each bar in the battery icon represents about 20% of charge. Once the battery is fully charged, the “charging motion” will stop, and the state of charge will remain at 100%.

System Status Troubleshooting

Indicator	Description	Troubleshooting
	<p>The AC output load exceeded the maximum power rating of 150 Watts. The internal inverter will shut off to avoid damaging the unit. When this happens, the digital display will show a flashing “ERROR” message with a sad face light bulb icon as shown. The “AC OUT” text will flash as well.</p>	<p>Disconnect all the load (s) and press the AC output switch to turn the inverter on to restore power. Once the AC output button is pressed, the message should be gone and the system should be back to normal.</p>
	<p>The DC outputs load exceeded the maximum current rating. The DC output will shut off to avoid damaging the unit. When this happens, the digital display will show a flashing “ERROR” message with a sad face light bulb icon as shown. The “DC OUT” text will flash as well.</p>	<p>Disconnect all the load (s) and press the DC output switch to turn the inverter on to restore power. Once the DC output button is pressed, the message should be gone and the system should be back to normal.</p>
Other Considerations		
AC output load exceeded the maximum rating while DC output is on (or vice versa)	If one of the outputs overloads while the other is in operation, the digital display will only flash the “ERROR” message and flash the output that has encountered the issue. Please correct the issue as described above.	
Unit won't power on	Try to flip the Main switch ON and OFF a couple times to check if there is a connection issue. If the unit still won't power on please call Renogy Technical Support to find a possible resolution.	
Unit not charging with the built-in solar panels	Make sure that the unit is not shaded or that the unit is not being blocked from sunlight. If the unit is exposed to full sunlight and still won't charge via solar please call Renogy Technical Support to find a possible resolution.	
Unit not charging with external solar panel	Please make sure that the DC power plug is in the right socket, and that is making proper connection. Make sure that the solar panel is not shaded or that is not being blocked from sunlight. If none of the above fixes the problem, please call Renogy Technical Support to find a possible resolution.	
Unit not charging via AC power cord	Please make sure that the AC power plug is making proper connection and both end plugs are all the way in. If none of above fixes the problem, please call Renogy Technical Support to find a possible resolution.	

Technical Specifications

Solar Panels

Description	Parameter
Maximum Power	10W (x2)
Cell Type	Monocrystalline
Operating Temperature	-40°F to +185°F

Built-in Electrical Components

Component	Parameter
Power inverter	150w, AC 110V ± 10%, 60 Hz
Battery	Lithium Polymer 12.1V, 16 Ah
Charge Controller	12V, 8A (rated current)
LED Flashlight	3W, lighting mode, SOS mode

Accessories

Accessory	Parameter
110V AC output	150w Max.
110V AC input	110V AC
12V DC power plug outputs	5A Max.
12V DC cigarette socket	8A Max.
Solar input	23V DC Max. 70w Max.
5V DC USB output	2A Max.

Physical Properties

Value	Parameter
Weight	12.0 lbs.
Dimension	15.20 x 11.81 x 3.84 inches
Package size	15.63 x 12.67 x 4.15 inches

Dimensions

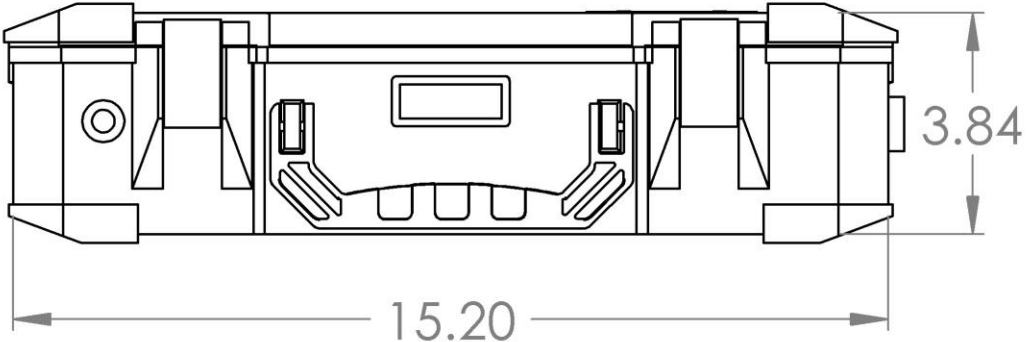
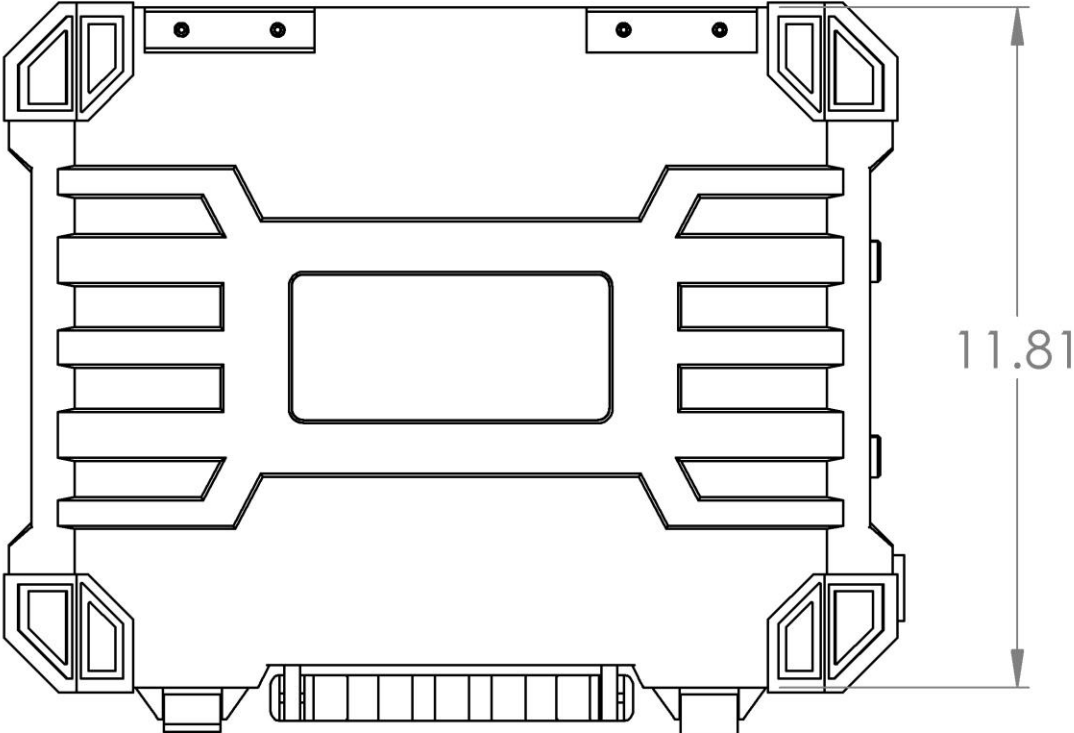

NOTE: All dimensions are in inches